

Table 01: ancient Kings of Israel & Judah

(1) DAVID
1010-970BC

=1 Michal; =2 Ahinoam; =3 Abigail; =4 Maachah; =5 Haggith
=6 Abital; =7 Eglah; =8 name unk; =9 name unk; =10 Bathsheba

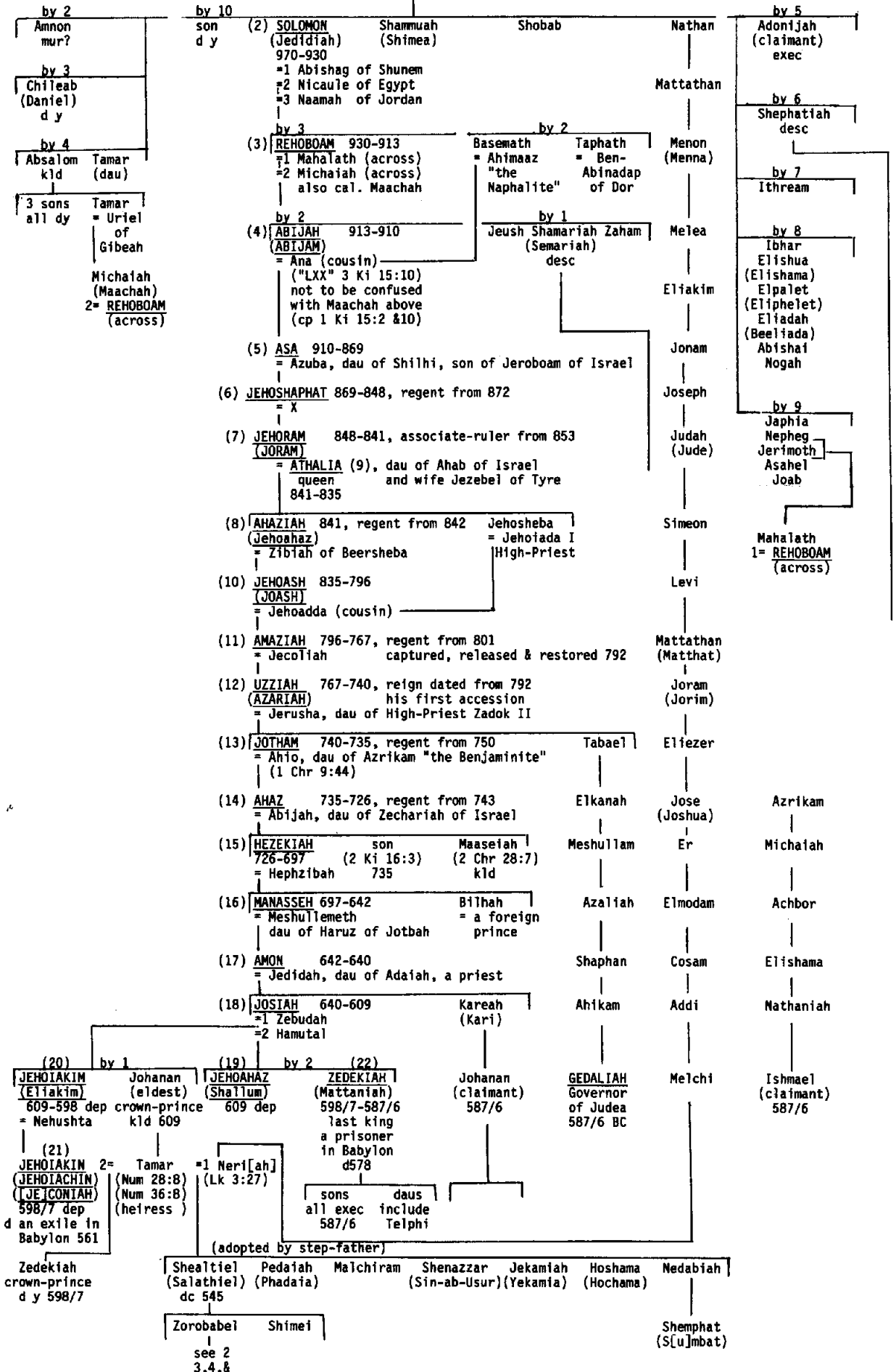

Table 02: the dynasty's post-exilic main-line

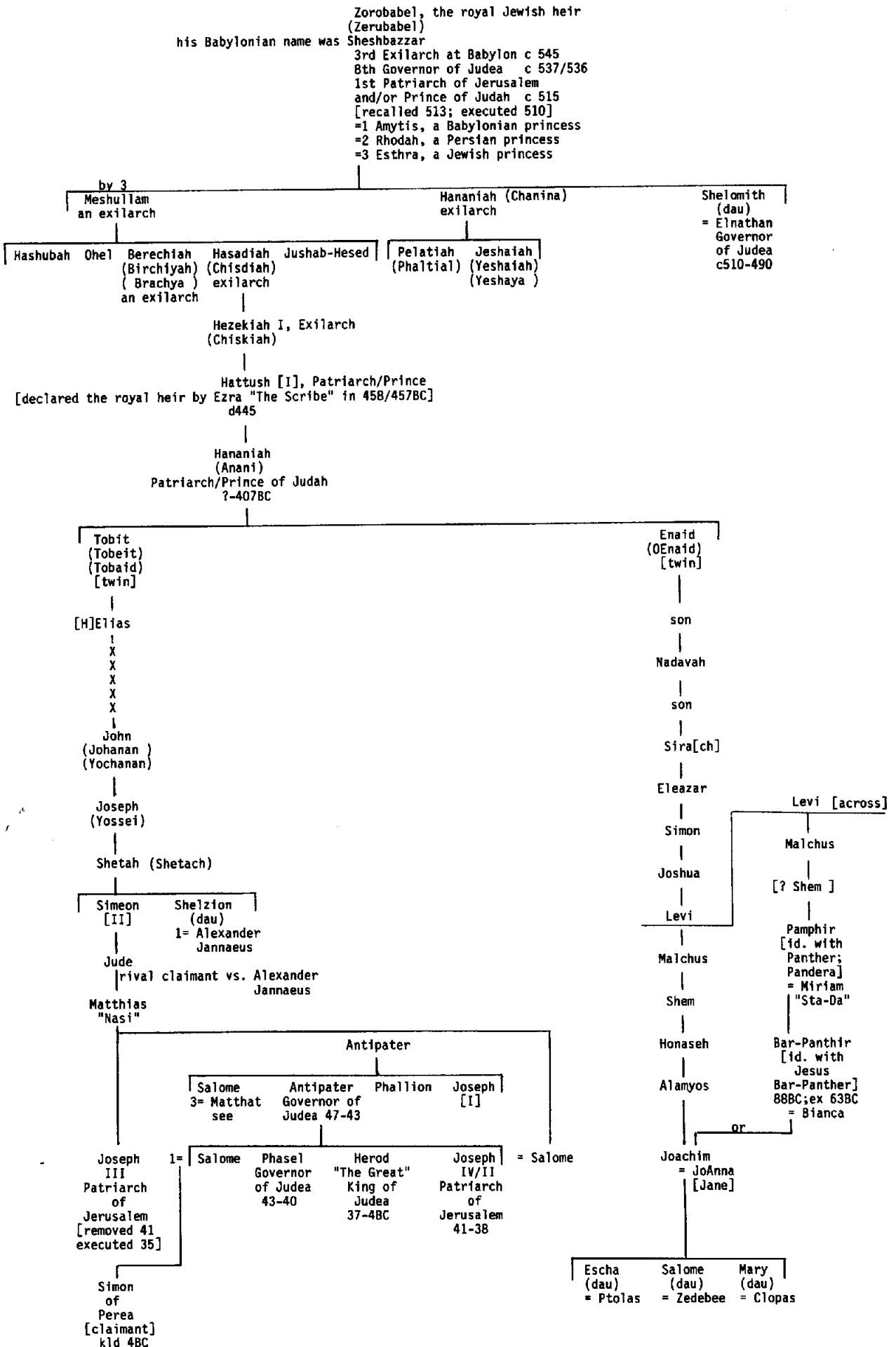
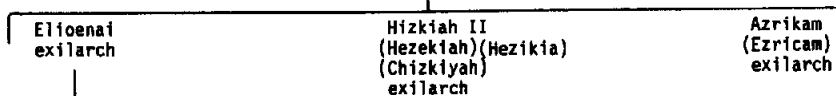
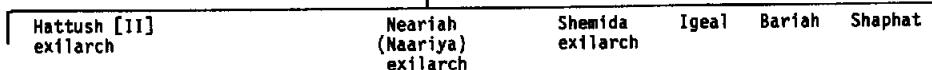
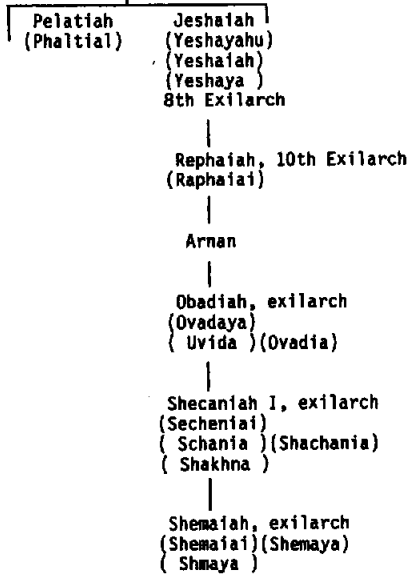
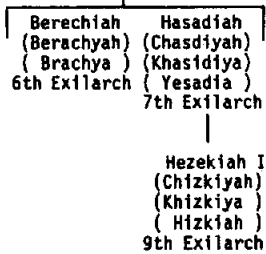
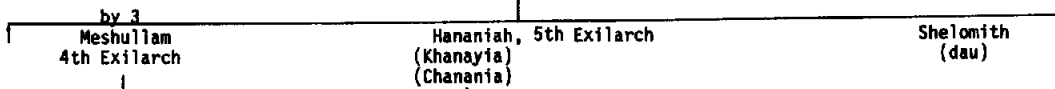

Table 04: the Yeshaiahite line

[see 1]

Zorobabel (Zerubabel), his Babylonian name was Sheshbazzar
 [the royal heir]
 3rd Babylonian Exilarch (545); 8th Governor of Judea (537/6); 1st Palestinian "Nasi" (515)
 ex 510BC
 =1 Amytis
 =2 Rhodah
 =3 Esthra



Na[k]hum [I]
exilarch

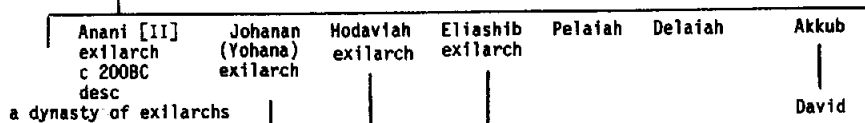

note: interim in the exilarchate
13BC-AD20

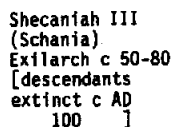
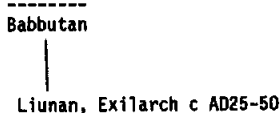
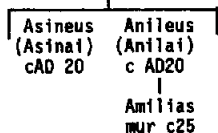

other
exilarchs
to AD
130

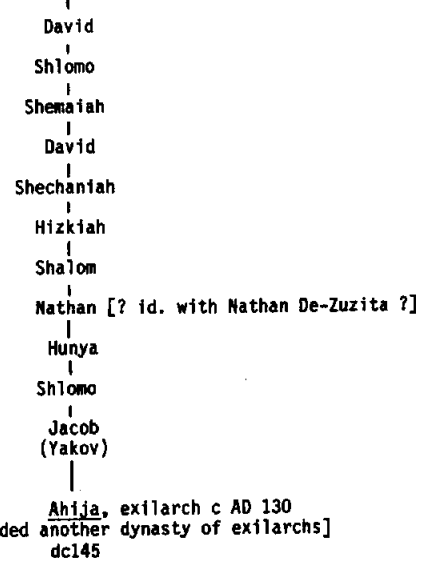

[see 5]

Table 05: medieval Jewish exilarchs

see 4

(1) Ahija[h], exilarch c AD 130

[founded another dynasty of exilarchs upon failure of senior descent-line]

dc 145

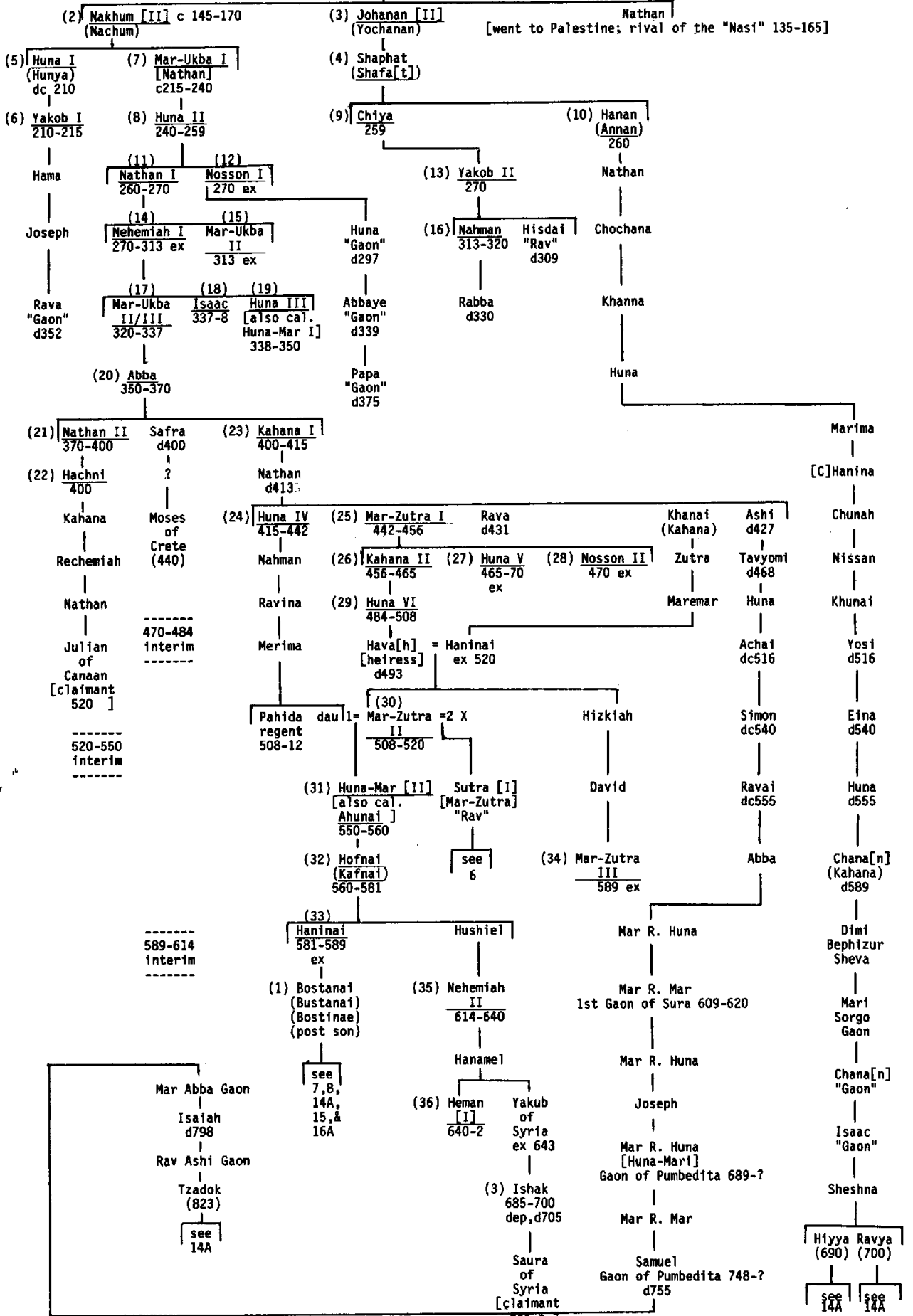

Table 6: Palestinian Patriarchs

Sutra [I]
 [Mar-Zutra]
 "Rav"
 [born same day of father's execution; son of the Babylonian Exilarch Mar-Zutra II; was carried as an infant to Palestine, where as an adult he was accepted as "Nasi" or "Patriarch", and, founded a new dynasty of the Palestinian "Nesi'im", circa 550]

Saada, "rav" of the Sanhedrin at Tiberias 575
 (Saadia)
 Guria
 (Guriya)
 Sutra II
 [Mar-Zutra]
 Yakov
 Shemaiah
 Haninai
 Migas (Magis; Magus; Misas), id. ? with Minis
 Nehemiah
 (Nekhemya)
 (Nechemia)
 Abdimi
 (Avidima)
 (Dimi)
 Abbai
 Pinhas (Pinkhas; Phinehas; Pinchus)

Hazub (Khazuv; Chazuv)
 [recognized by the Jews of Palestine as the royal Davidic heir, though his distant cousin, the Babylonian Exilarch, in Iraq, made the same claim; was the last prince of the Davidic Dynasty mentioned in the "Seder Olam Zuta", the medieval Jewish chronicle]

David, a rabbi
 Nathan
 Avraham
 Zakkai
 David
 Hizkiya
 David
 Hiyya [in service of King Alfonso I of Portugal]
 (Chiya)
 Al-Daudi
 d1154
 Yaish
 d1196
 Yahya [made "Lord of Aldeia dos Negros" by King Alfonso II of Portugal, thus, called Don Yahya "El Negro"; the eponymous ancestor of the "Ibn Yahya" Family]
 Ha-Nasi
 d1222

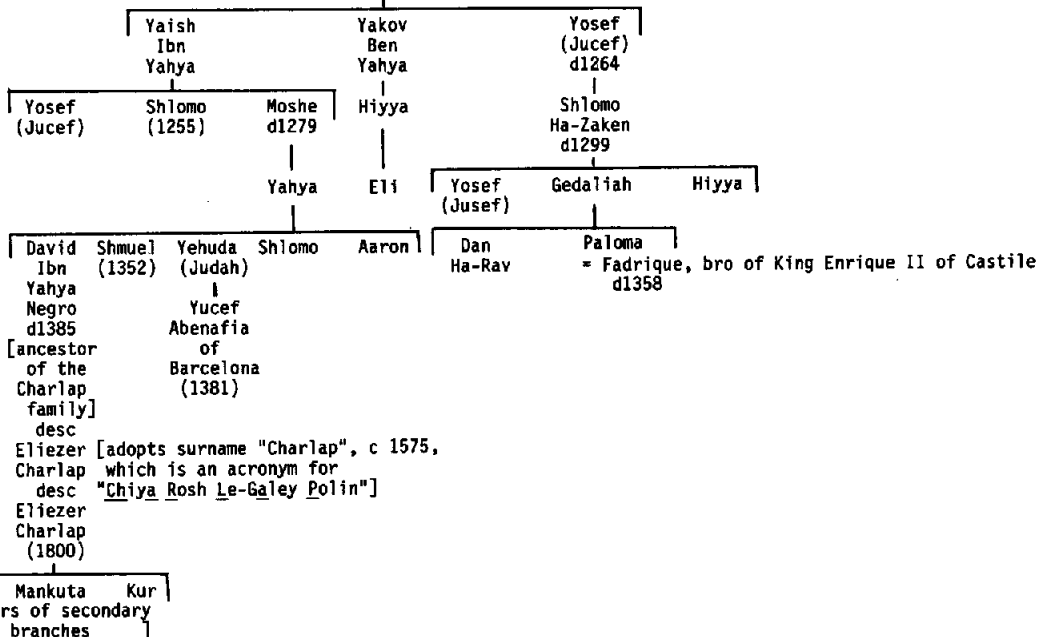

Table 07: medieval Jewish exilarchs: House of Bostanai

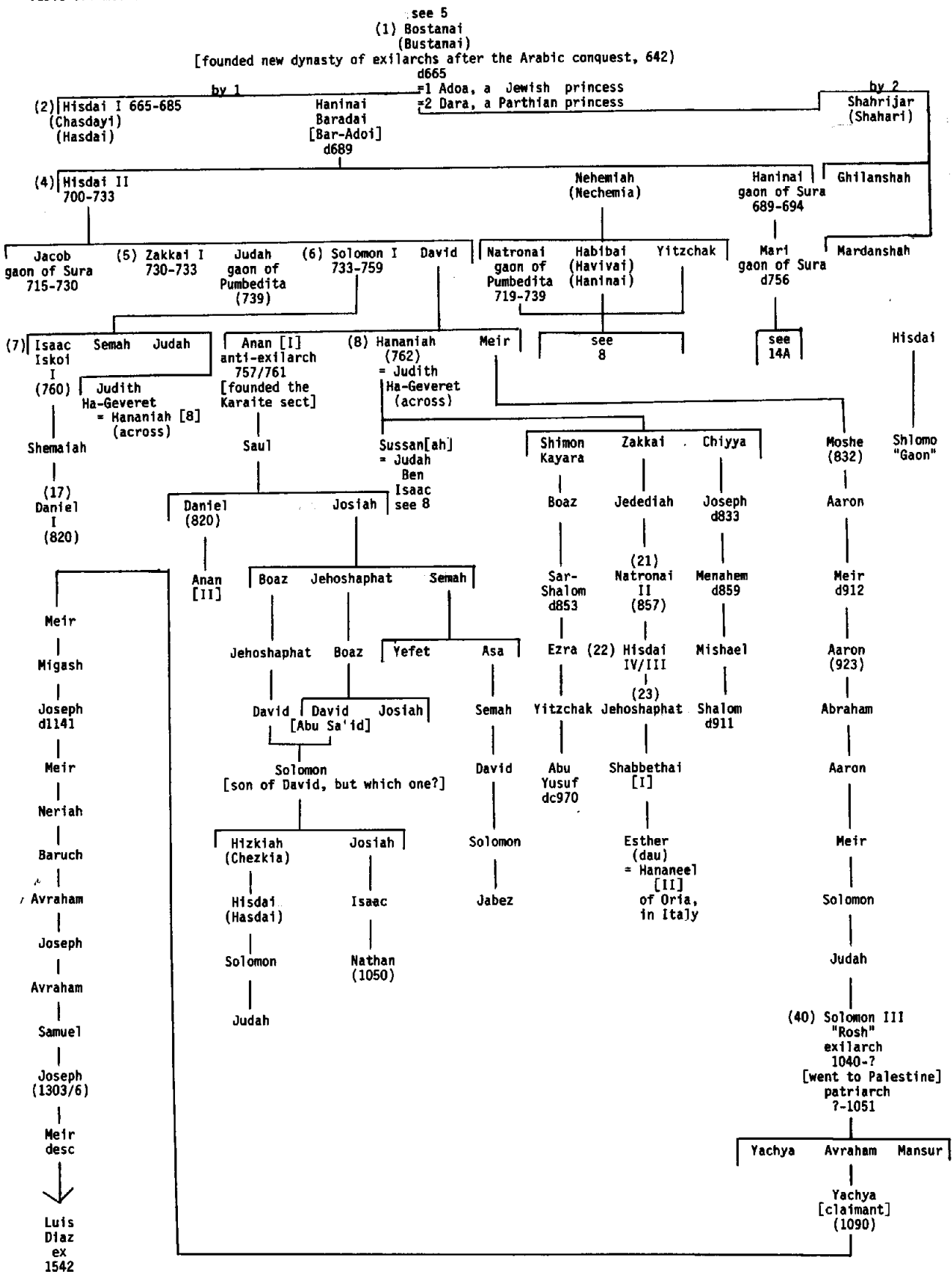
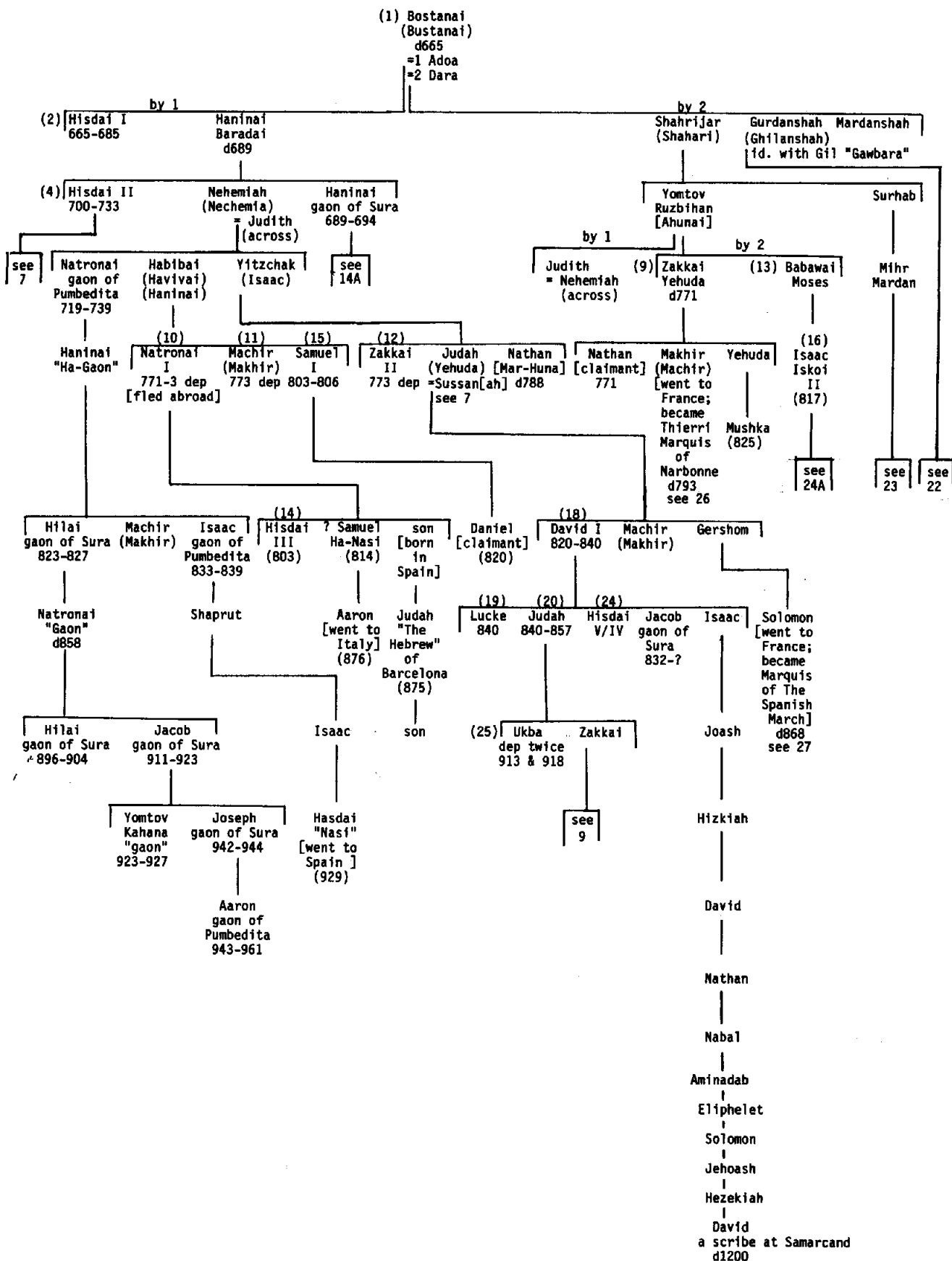

Table 08: medieval Jewish exilarchs: House of Bostanai (continued)



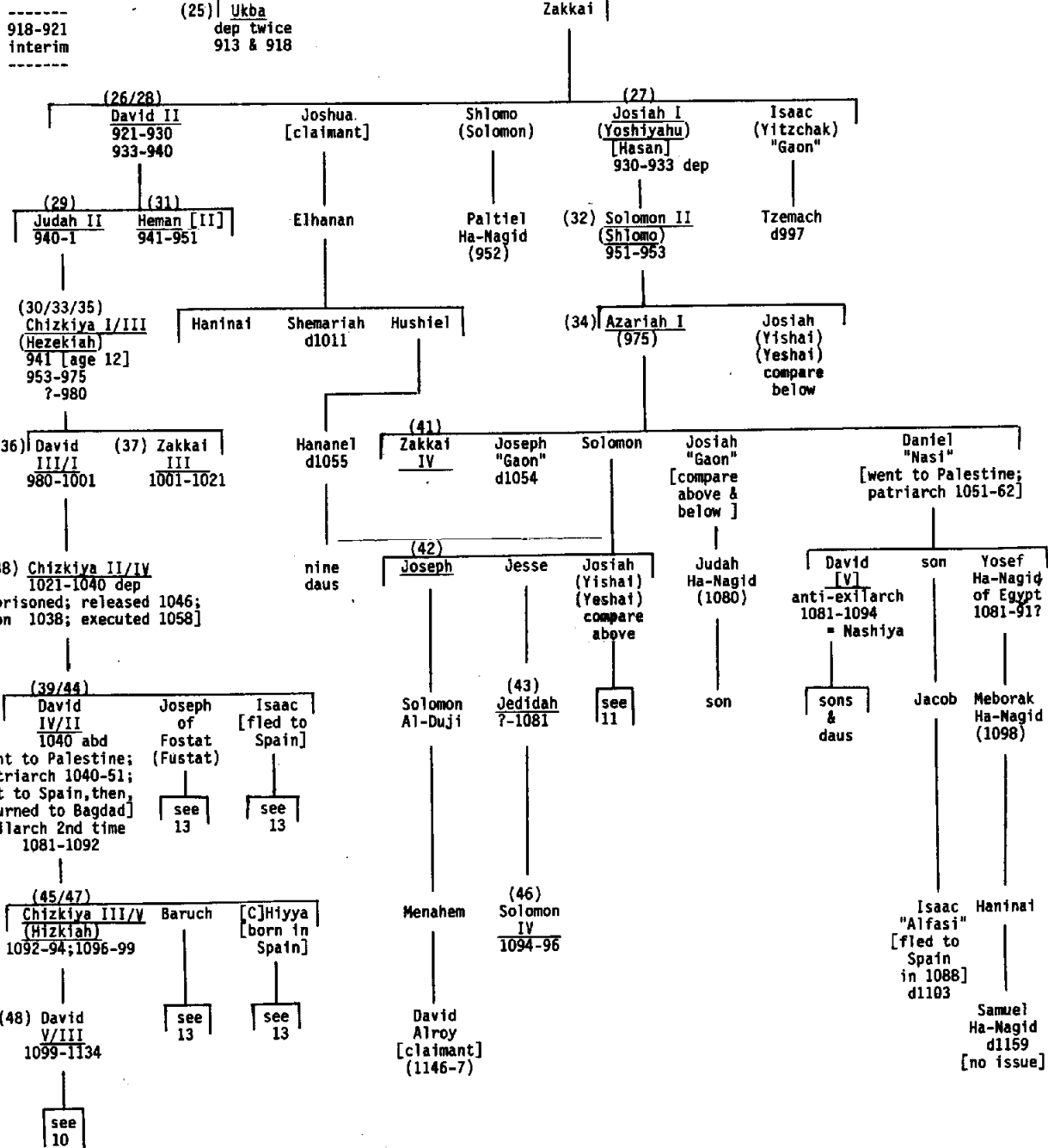

Table 10: medieval Jewish exilarchs (continued)

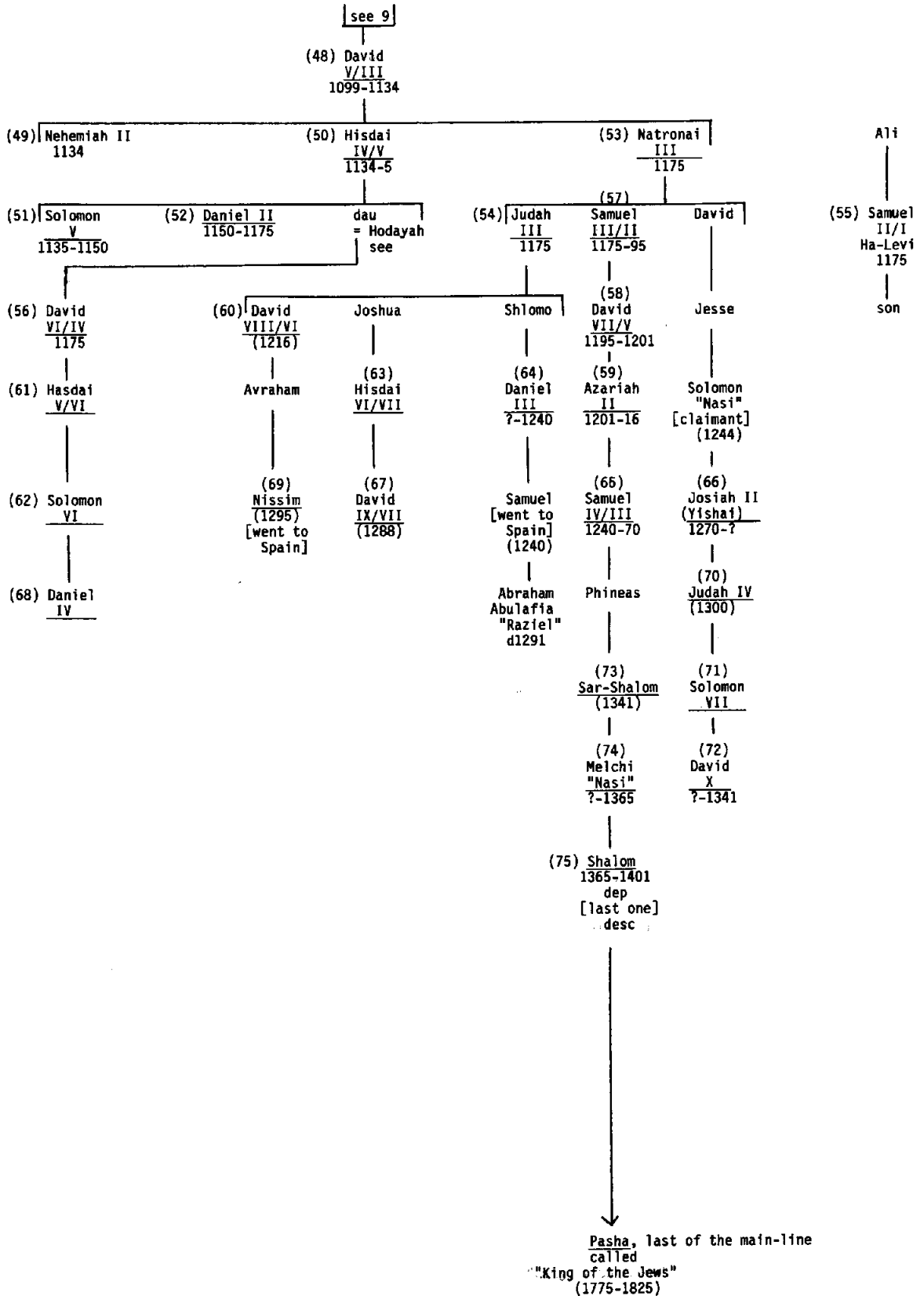
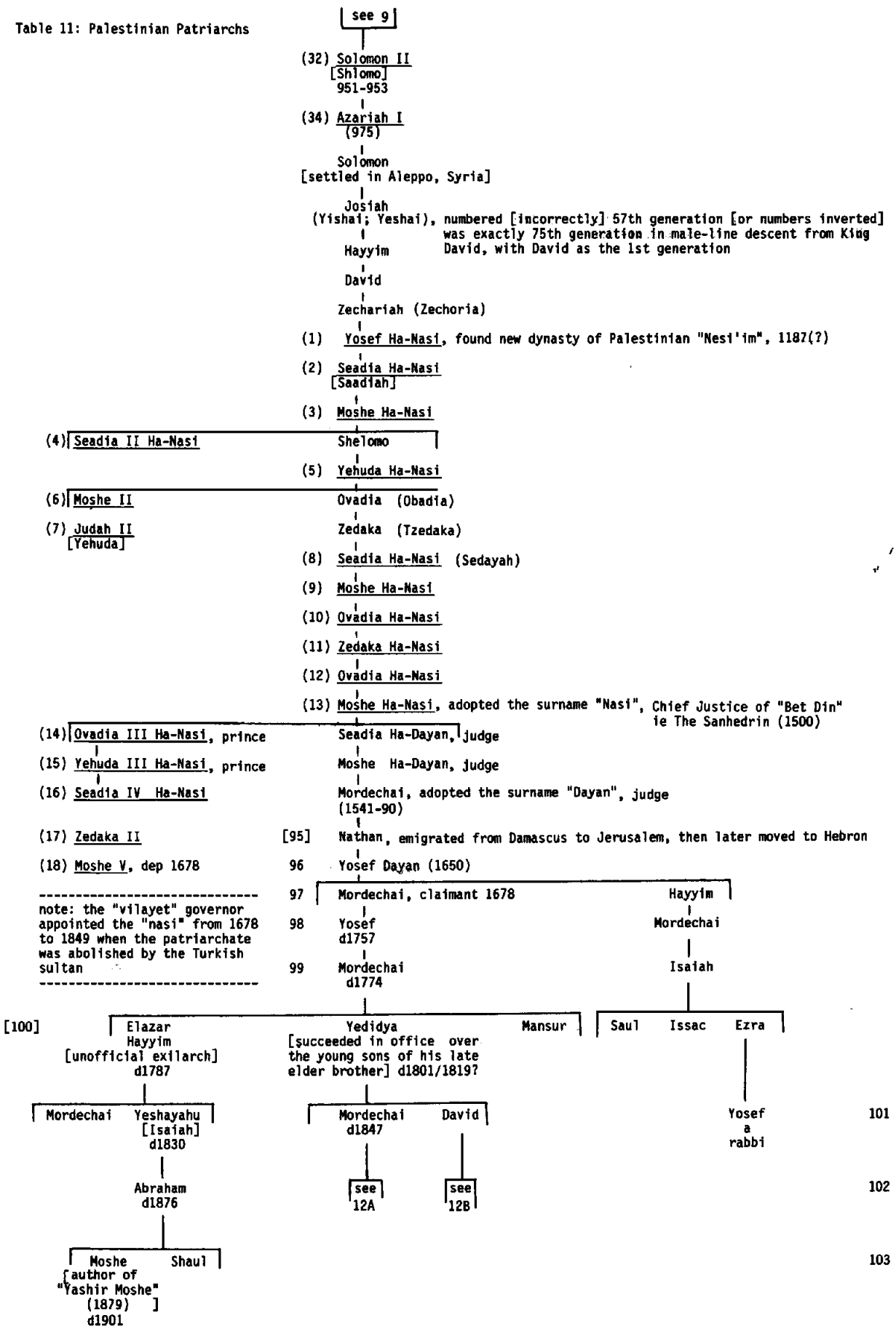

Table 11: Palestinian Patriarchs



note: the "vilayet" governor appointed the "nasi" from 1678 to 1849 when the patriarchate was abolished by the Turkish sultan

Table 12A: modern Jewish royal house

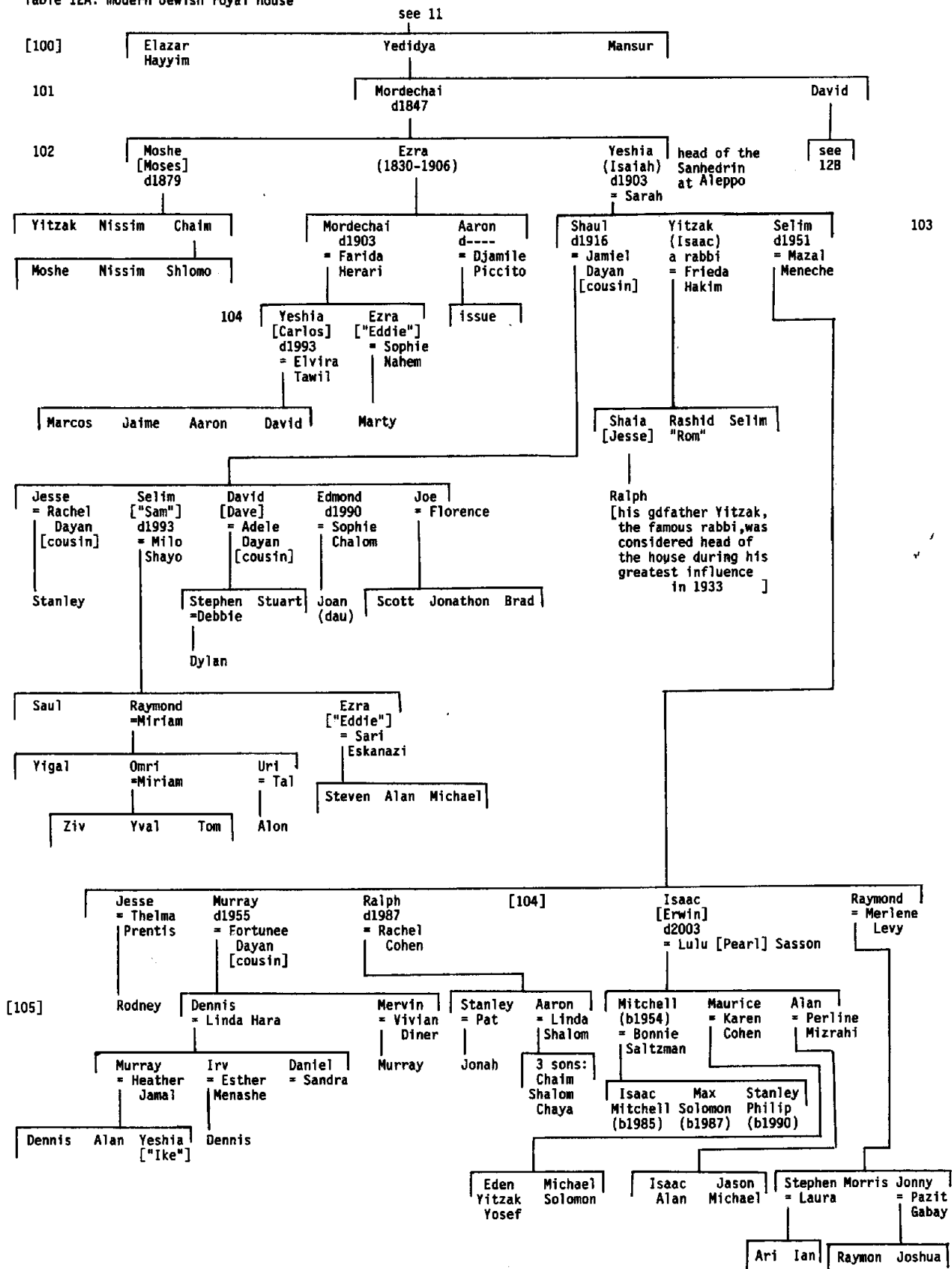

Table 12B: modern Jewish royal house

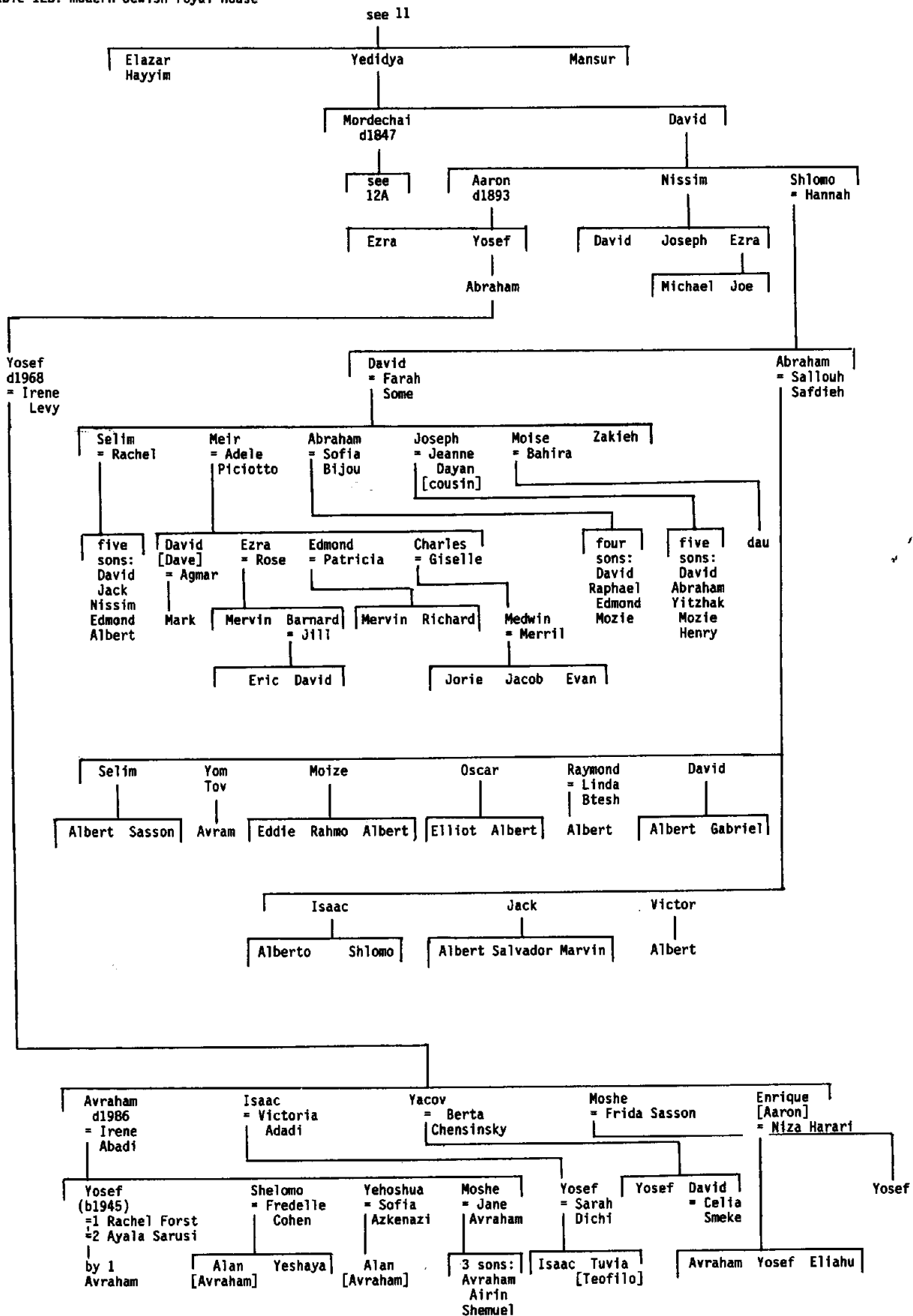

Table.13: medieval descents

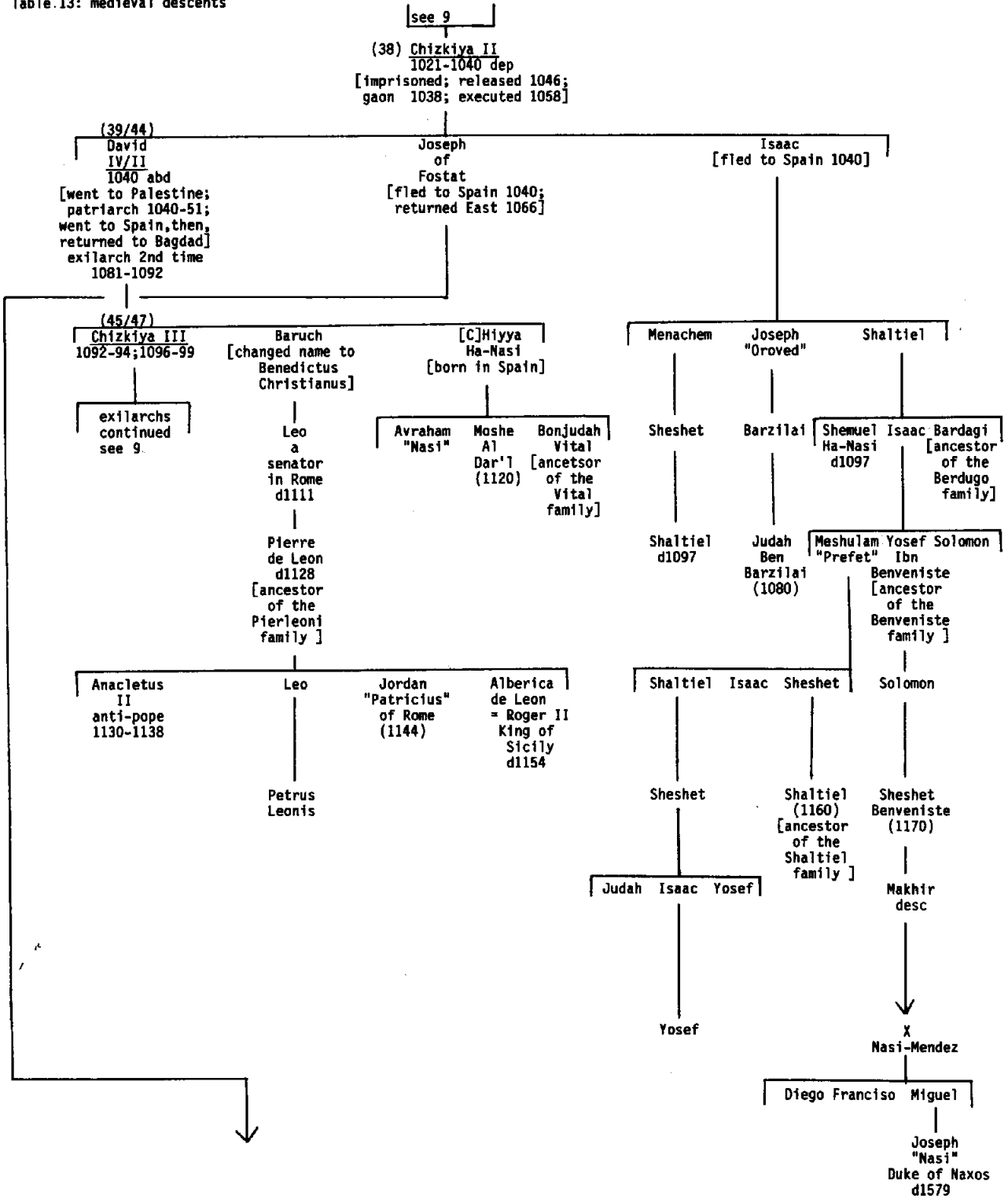

Table 14A: ancestry of "The Maharal" of Prague

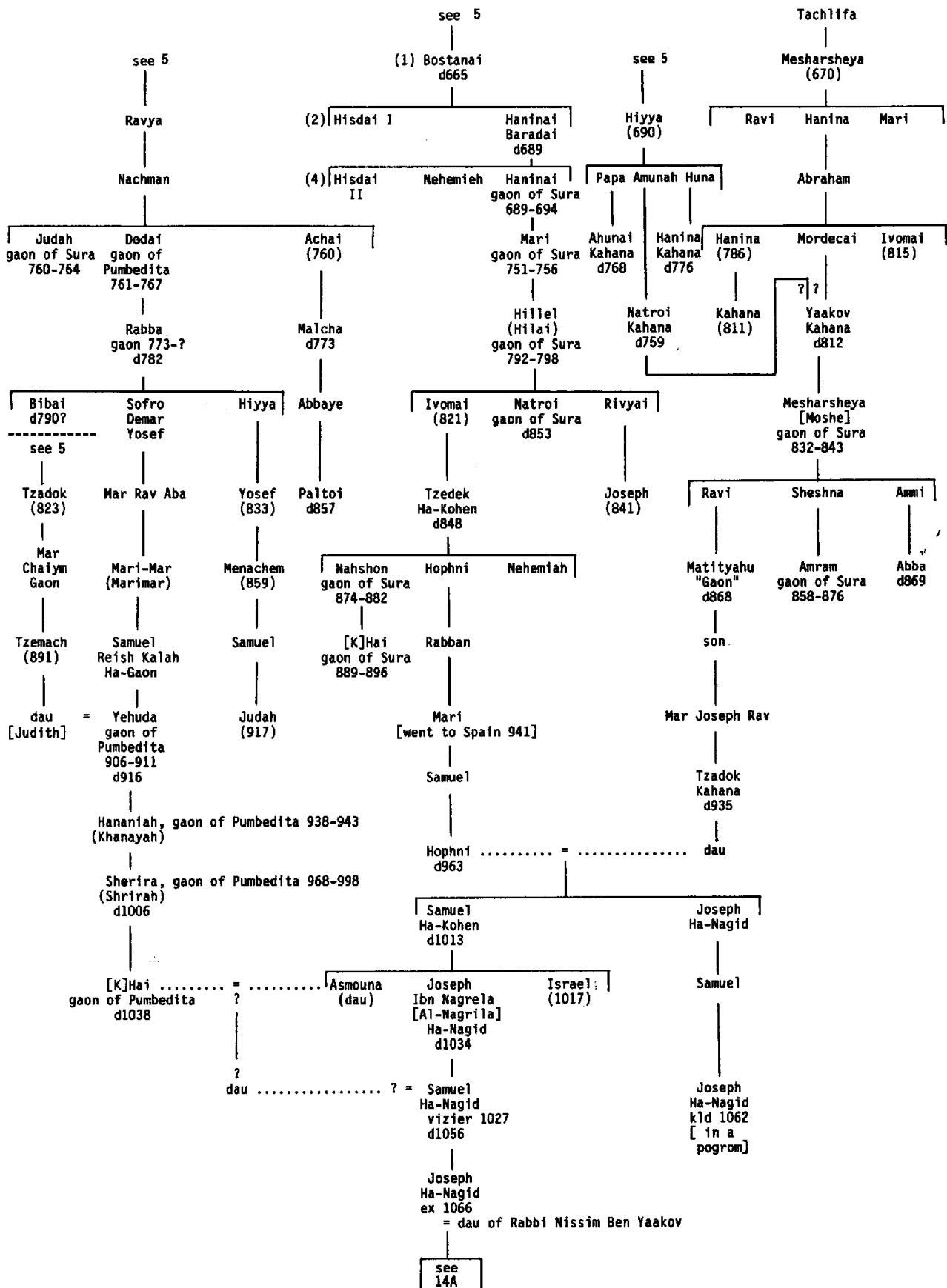

Table 14B: ancestry of "The Maharal" of Prague (continued)

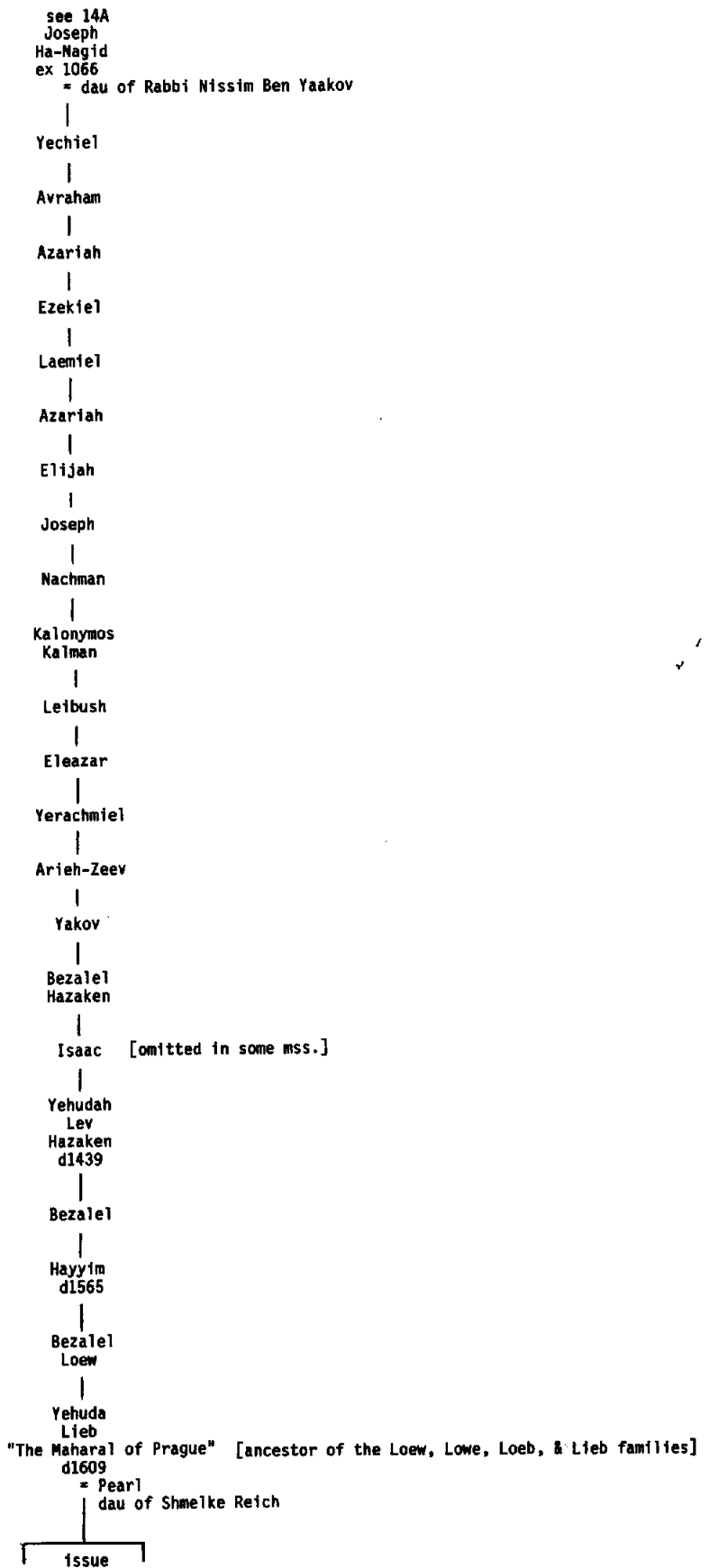

Table 15A: another Davidic descent-line

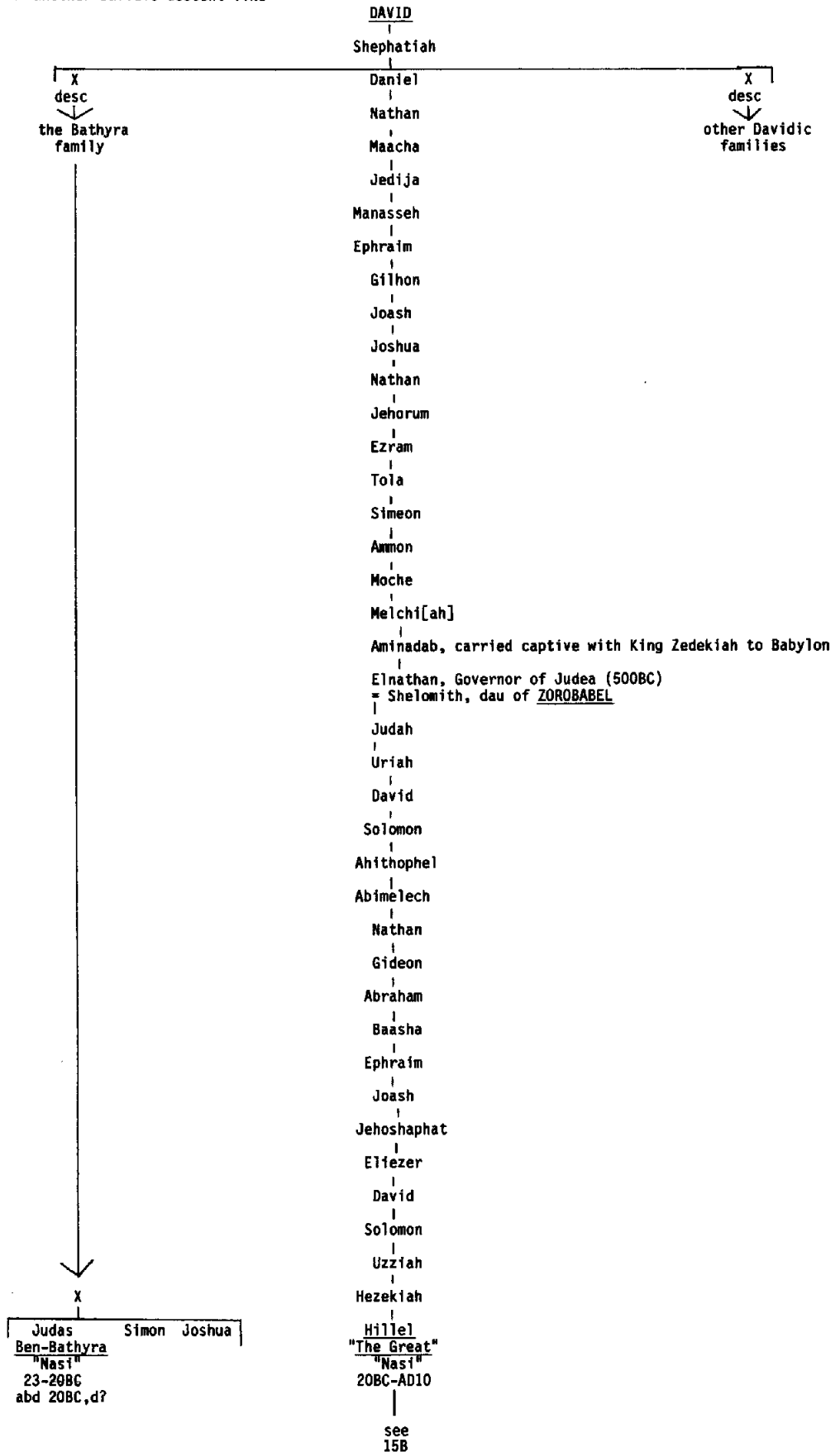

Table 15B: Palestinian Patriarchs

